

Winger Electronics WEMGN01-C2M 0603 SMD LED

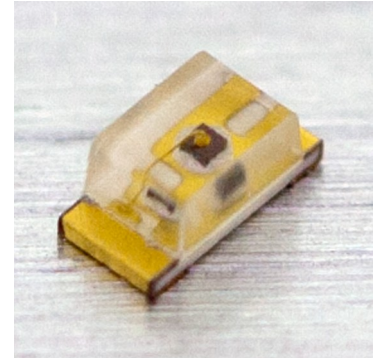

ATTENTION
OBSERVE PRECAUTIONS
FOR HANDLING
ELECTROSTATIC
SENSITIVE DEVICES



Description

- 0603 SMD LED
- Emitting Color: Green

Dimension figure

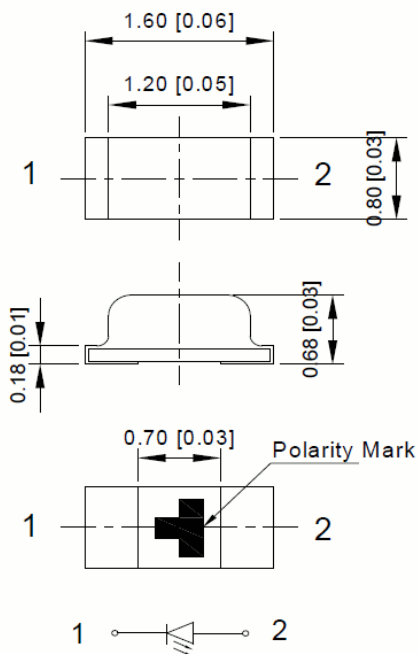

Recommended Soldering Pattern

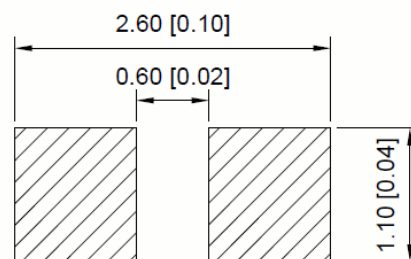

Absolute Maximum Ratings

Item	Symbol	Absolute Maximum Rating	Unit
Forward Current	I_F	20	mA
Peak Forward Current *	I_{FP}	100	mA
Reverse Voltage	V_R	5	V
Power Dissipation	P_O	66	mW
Operating Temperature	T_{OPR}	-40 ~ +85	°C
Storage Temperature	T_{stg}	-40 ~ +100	°C
Lead Soldering Temperature	T_{SOL}	< 3 sec @ < 300	°C

* I_{FP} Conditions: 1/10 Duty Cycle, 0.1ms Puls Width

Typical Optical/Electrical Characteristics

Item	Symbol	Condition	Min.	Typ.	Max.	Unit
Forward Voltage	V_F	$I_F=20mA$	2,7	3	3,3	V
50% Power Angle			-	130	-	deg
Luminous Intensity	I_V		600	800	1000	mcd
Dominant Wavelength	λ_D		515	520	527	nm
Color Temperature	T_c		-	-	-	K
Recommended Forward Current	$I_{F(rec)}$		-	10	-	mA
Reverse Current	I_R	$V_R=5V$	-	-	10	μA

Notes:

1. It's strongly recommended to limit die temperature to 55°C
2. Absolute maximum ratings $T_a=25^\circ C$
3. Measurement Tolerances of Forward Voltage $\pm 0.1V$
4. Measurement Tolerances of peak wavelength $\pm 2.0nm$
5. Measurement Tolerances of luminous intensity $\pm 15\%$
6. Measurement Tolerances of angle intensity $\pm 15\%$

Typical electrical and optical characteristics

Ambient Temperature vs. Forward Current

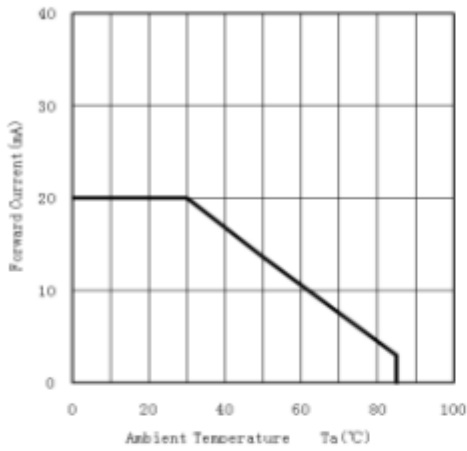

Forward Current VS. Relative Intensity

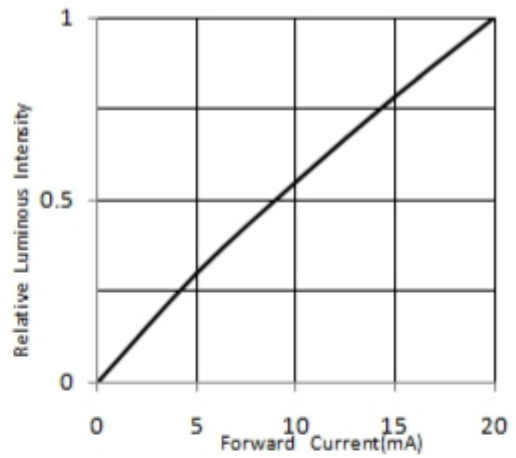

Forward Voltage VS. Forward Current

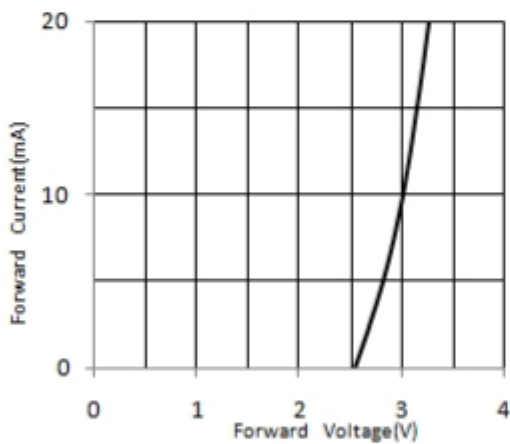

Ambient Temperature VS. Relative Intensity

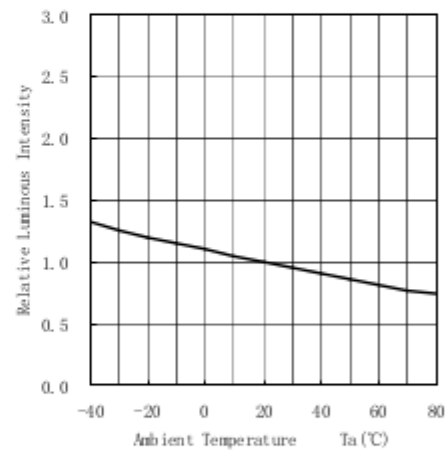

Relative spectral emission

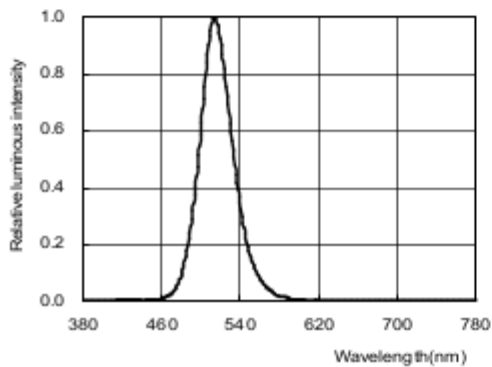

Radiation diagram

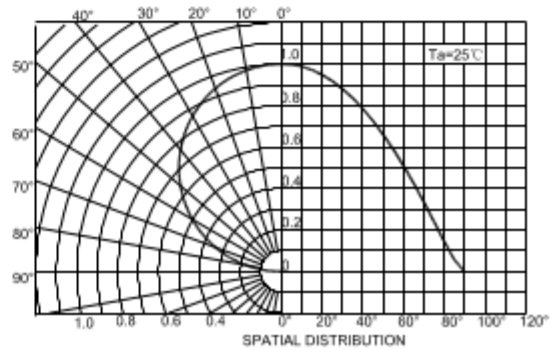

Tape reel dimensions

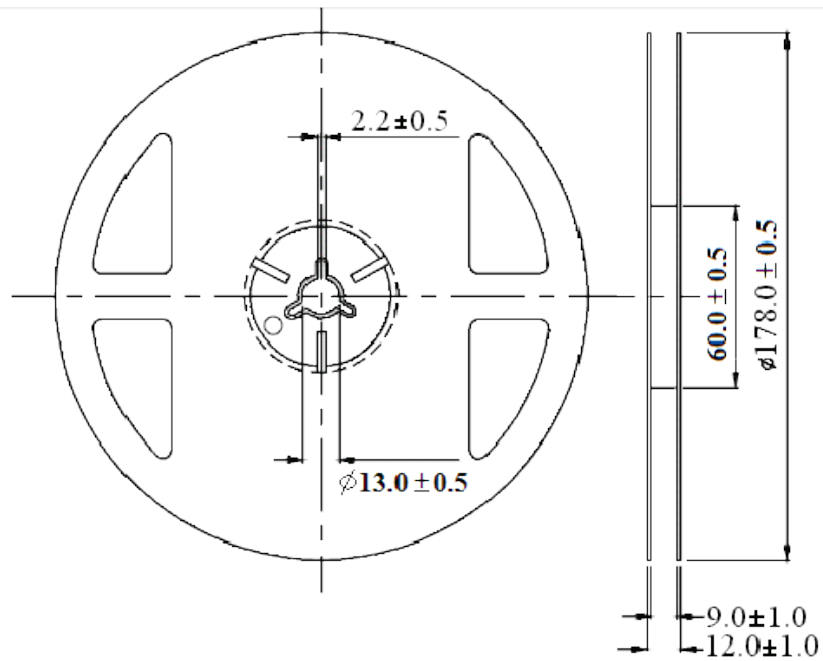

Unit: mm
Tolerance: ± 0.25 mm

Carrier Tape Dimensions:

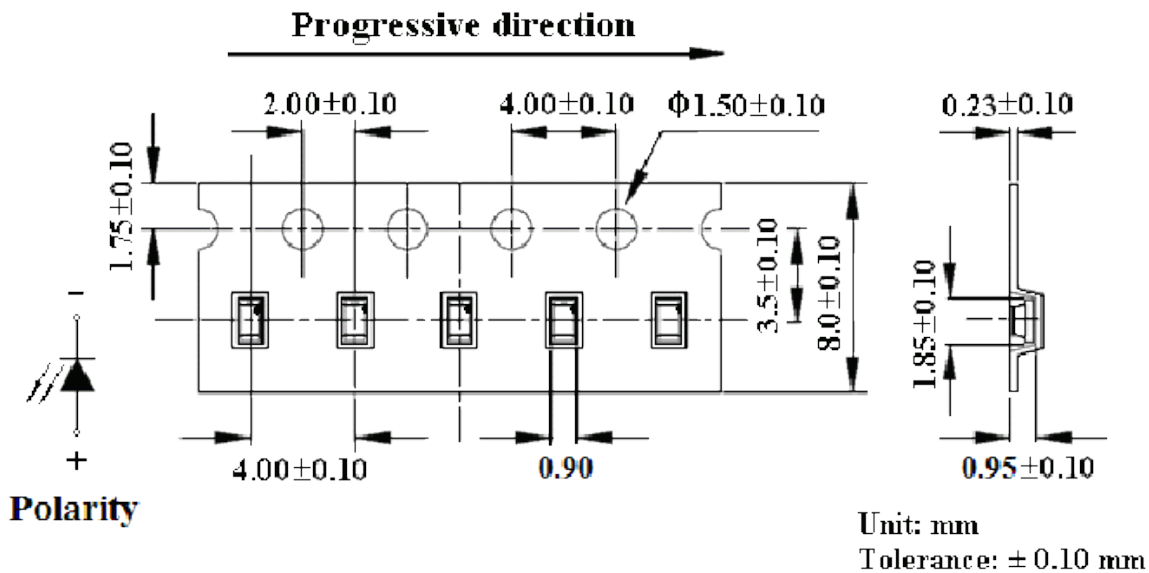

Unit: mm
Tolerance: ± 0.10 mm

QTY: 4000pcs per reel

Reflow Soldering Profile

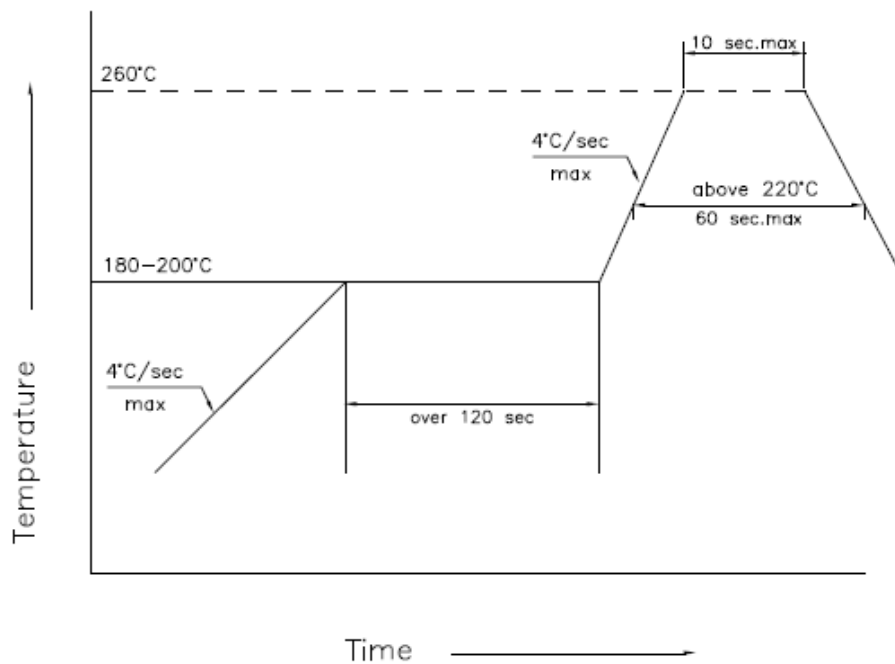

Storage

1. Do not open moisture proof bag before ready to use
2. Before opening the package, LEDs should be kept at 30°C or less and 80% RH or less.
3. After opening the package, LEDs should be kept at 30°C or less and 60% RH or less.
4. The LEDs should be used within one year.
5. The LEDs should be used within 72 hours after opening the package (MSL-Level 4)
6. If the silica gel bag has fabled away or storage time has exceeded, baking treatment should be performed. Conditions: 70±3°C for 24 hours.

Warranty

- (1) Perform an acceptance inspection on arrival of the goods. Return the defectives if any stipulating the disqualification and quantity.
- (2) Embedding the LEDs into the application and the verification of life and other qualities in practical use shall be executed by user.
- (3) Do not use the LEDs for the applications that require the higher reliability and security and that may endanger life and health by the breakdown and the malfunction. Seller shall not bear any responsibility or liability with respect to any claims and damages caused by user's usage of the LEDs without following our intended purpose or any written consent.
- (4) Seller shall not bear responsibility for any damages or defects caused by improper operation at the current in excess of the absolute maximum ratings that are not covered by warranty.