

# Winger Electronics WEMYE01-C1M 0603 SMD LED

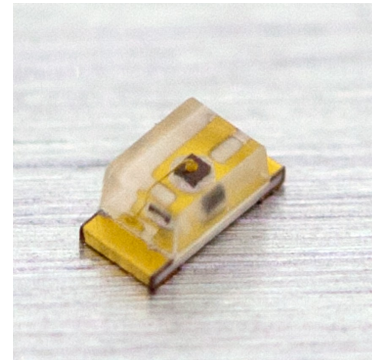

**ATTENTION**  
OBSERVE PRECAUTIONS  
FOR HANDLING  
ELECTROSTATIC  
SENSITIVE DEVICES



## Description

- 0603 SMD LED
- Emitting Color: Yellow (amber)

## Dimension figure

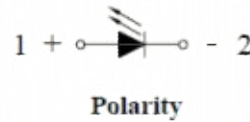
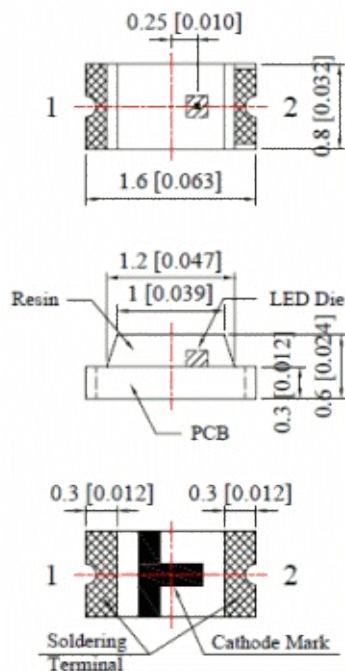

## Recommended Soldering Pad Dimensions

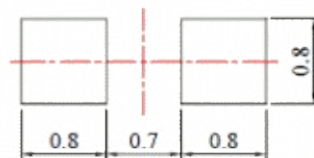

Unit: mm  
Tolerance:  $\pm 0.10\text{mm}$

## Absolute Maximum Ratings

Item	Symbol	Absolute Maximum Rating	Unit
Forward Current	$I_F$	25	mA
Peak Forward Current *	$I_{FP}$	100	mA
Reverse Voltage	$V_R$	5	V
Power Dissipation	$P_O$	60	mW
Operating Temperature	$T_{OPR}$	-40 ~ +70	°C
Storage Temperature	$T_{stg}$	-40 ~ +85	°C
Lead Soldering Temperature	$T_{SOL}$	Max. 5 sec @ 260	°C

\* $I_{FP}$  Conditions: 1/10 Duty Cycle, 0.1ms Puls Width

## Typical Optical/Electrical Characteristics

Item	Symbol	Condition	Min.	Typ.	Max.	Unit
Forward Voltage	$V_F$	$I_F=20mA$	1,8	2	2,4	V
50% Power Angle			-	130	-	deg
Luminous Intensity	$I_V$		80	120	140	mcd
Dominant Wavelength	$\lambda_D$		585	-	595	nm
Color Temperature	$T_C$		-	-	-	K
Recommended Forward Current	$I_{F(rec)}$		-	-	20	mA
Reverse Current	$I_R$	$V_R=5V$	-	-	10	$\mu A$

### Notes:

1. It's strongly recommended to limit die temperature to 55°C
2. Absolute maximum ratings  $T_a=25^\circ C$
3. Measurement Tolerances of Forward Voltage  $\pm 0.1V$
4. Measurement Tolerances of peak wavelength  $\pm 2.0nm$
5. Measurement Tolerances of luminous intensity  $\pm 15\%$
6. Measurement Tolerances of angle intensity  $\pm 15\%$

# Typical electrical and optical characteristics

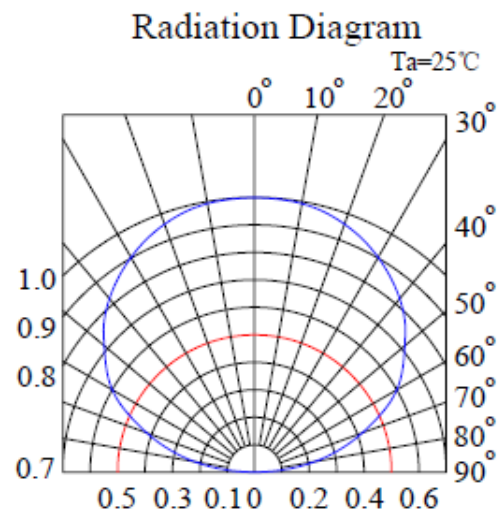
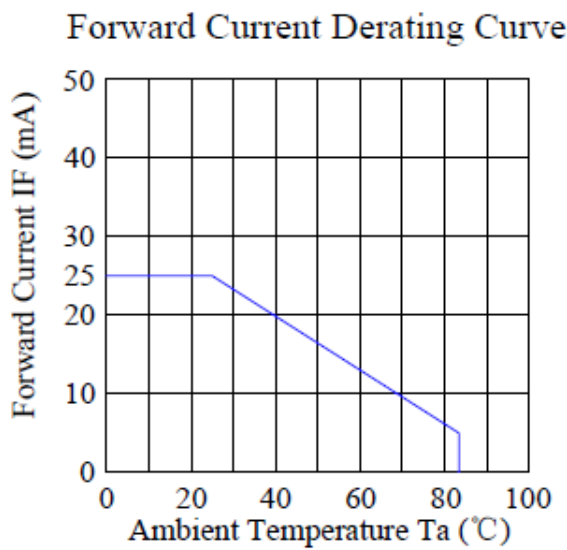
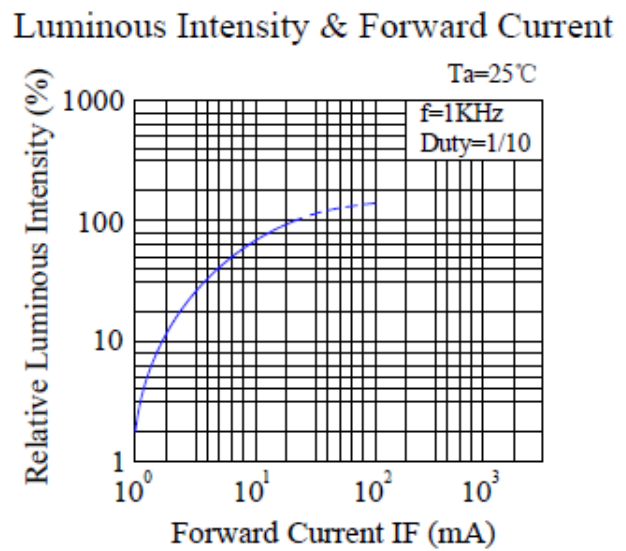
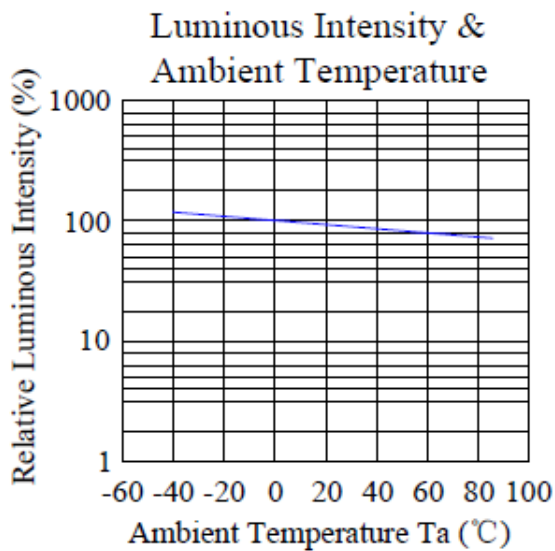
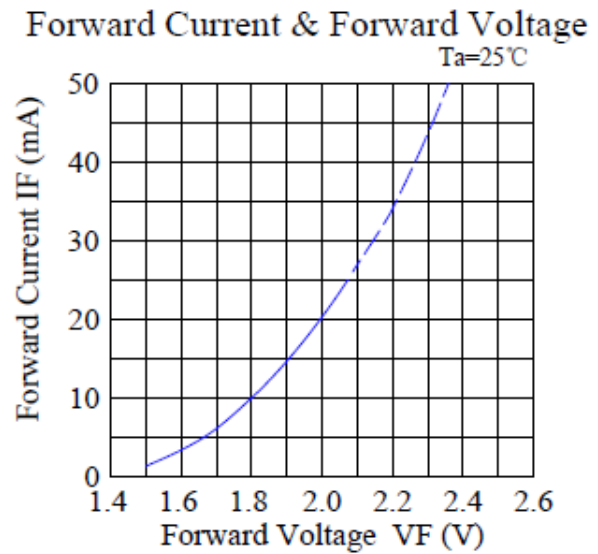
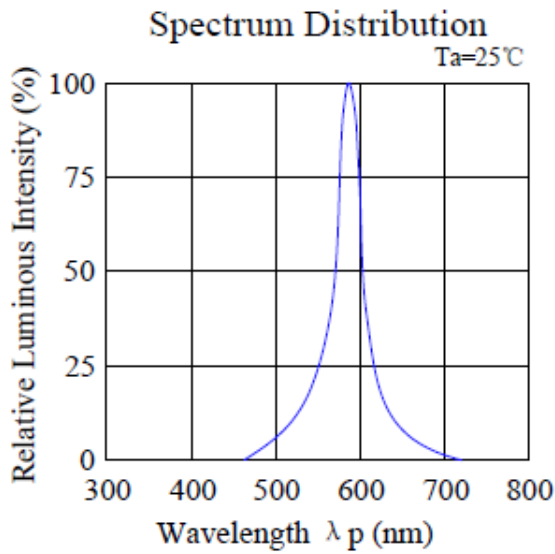

## Reflow soldering profile

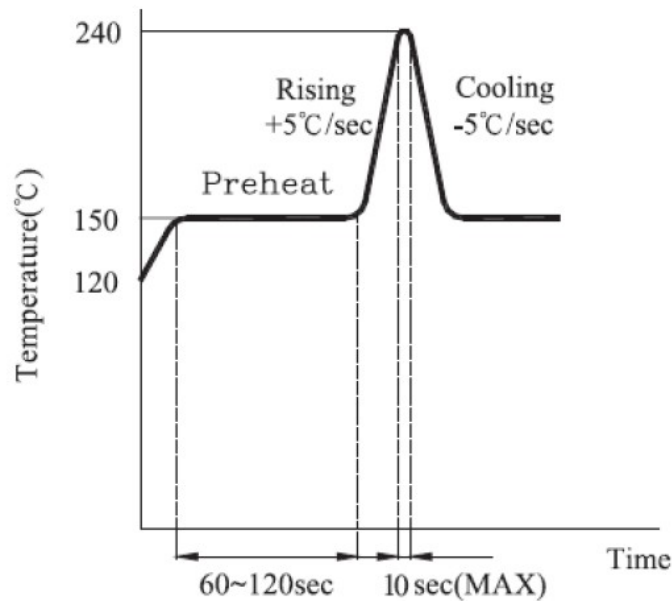

## Storage

1. Do not open moisture proof bag before ready to use
2. Before opening the package, LEDs should be kept at 30°C or less and 80% RH or less.
3. After opening the package, LEDs should be kept at 30°C or less and 60% RH or less.
4. The LEDs should be used within one year.
5. The LEDs should be used within 168 hours (7 days) after opening the package.
6. If the silica gel bag has fabled away or storage time has exceeded, baking treatment should be performed. Conditions: 60±5°C for 24 hours.

## Warranty

- (1) Perform an acceptance inspection on arrival of the goods. Return the defectives if any stipulating the disqualification and quantity.
- (2) Embedding the LEDs into the application and the verification of life and other qualities in practical use shall be executed by user.
- (3) Do not use the LEDs for the applications that require the higher reliability and security and that may endanger life and health by the breakdown and the malfunction. Seller shall not bear any responsibility or liability with respect to any claims and damages caused by user's usage of the LEDs without following our intended purpose or any written consent.
- (4) Seller shall not bear responsibility for any damages or defects caused by improper operation at the current in excess of the absolute maximum ratings that are not covered by warranty.

## Tape reel dimensions

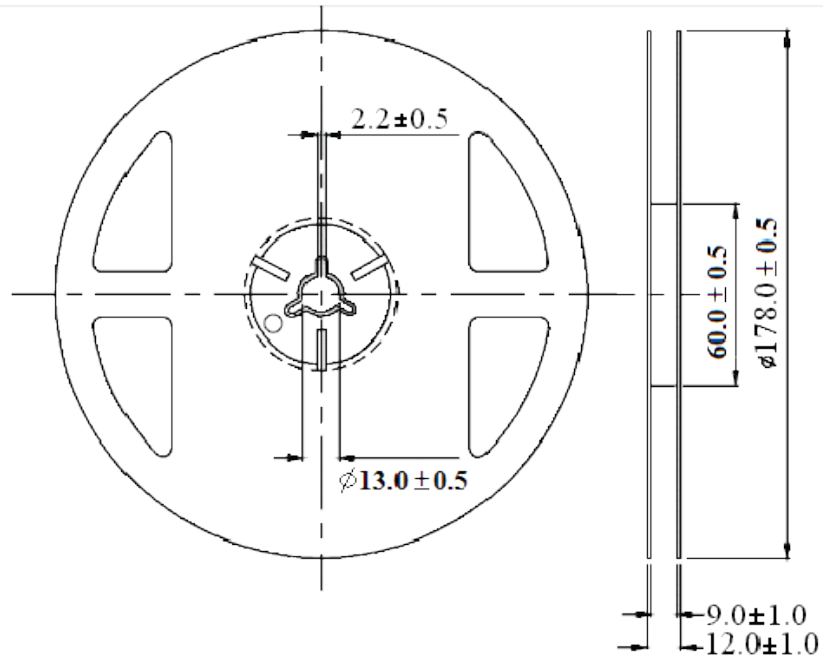

Unit: mm  
Tolerance:  $\pm 0.25$ mm

## Carrier Tape Dimensions:

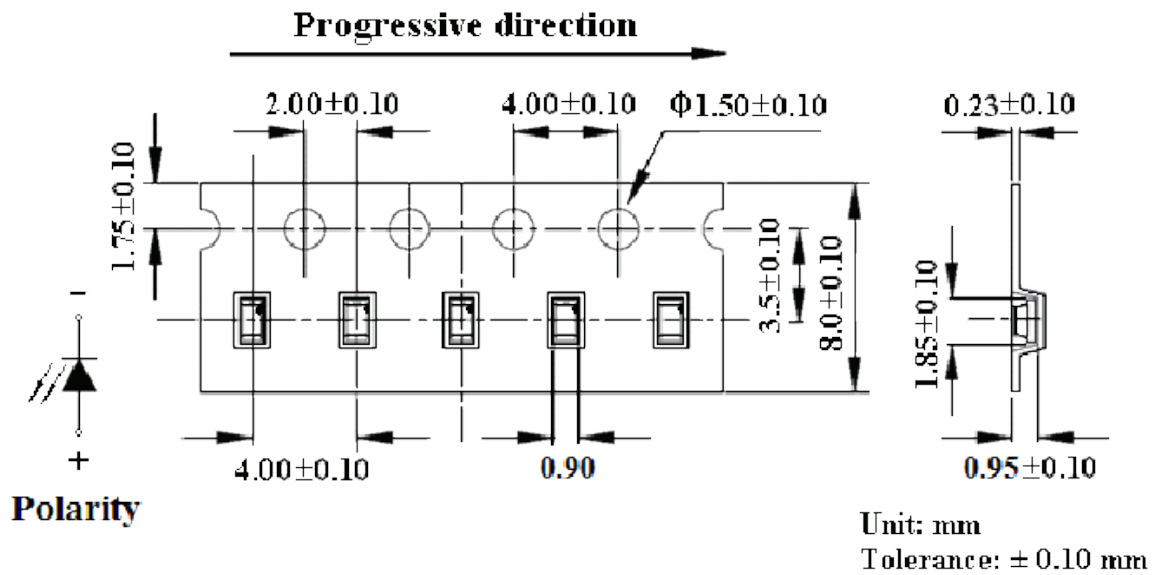

Unit: mm  
Tolerance:  $\pm 0.10$  mm